

ICS

INTEGRATED

COCKPIT

SYSTEM



This BMC innovation made its debut on the Roadmachine 01 in 2016 and is now standard on nearly all BMC bikes.

ICS offers:

- Smooth, hidden cable routing from handlebar to frame for a clean look and strong build.
- A refined stem-to-frame interface that enhances aerodynamics, aesthetics and mechanical integrity.
- Easy fit adjustments: spacers in 3 mm and 10 mm heights let you fine-tune stack without disconnecting hoses.
- Compatibility with both hydraulic brake hoses and shift hoses inside the cockpit area, plus the option to use ICS on bikes with external routing thanks to the standard 1" 1/8 steerer.

ICS delivers integrated style and performance, making the cockpit cleaner, stronger and more adjustable.

Identifying Frame and Cockpit compatibility

ICS requires a fit between 3 elements: [1] Frame, [2] Cockpit or Stem, and [3] Top cones and spacers.

When you START WITH A BIKE

Check [1] **Frame Interface**.



In [2] **Stem Interface**,
find a cockpit or stem with the same interface.



Pick matching Top Cone and Spacers suggested by [2] **Stem Interface**.

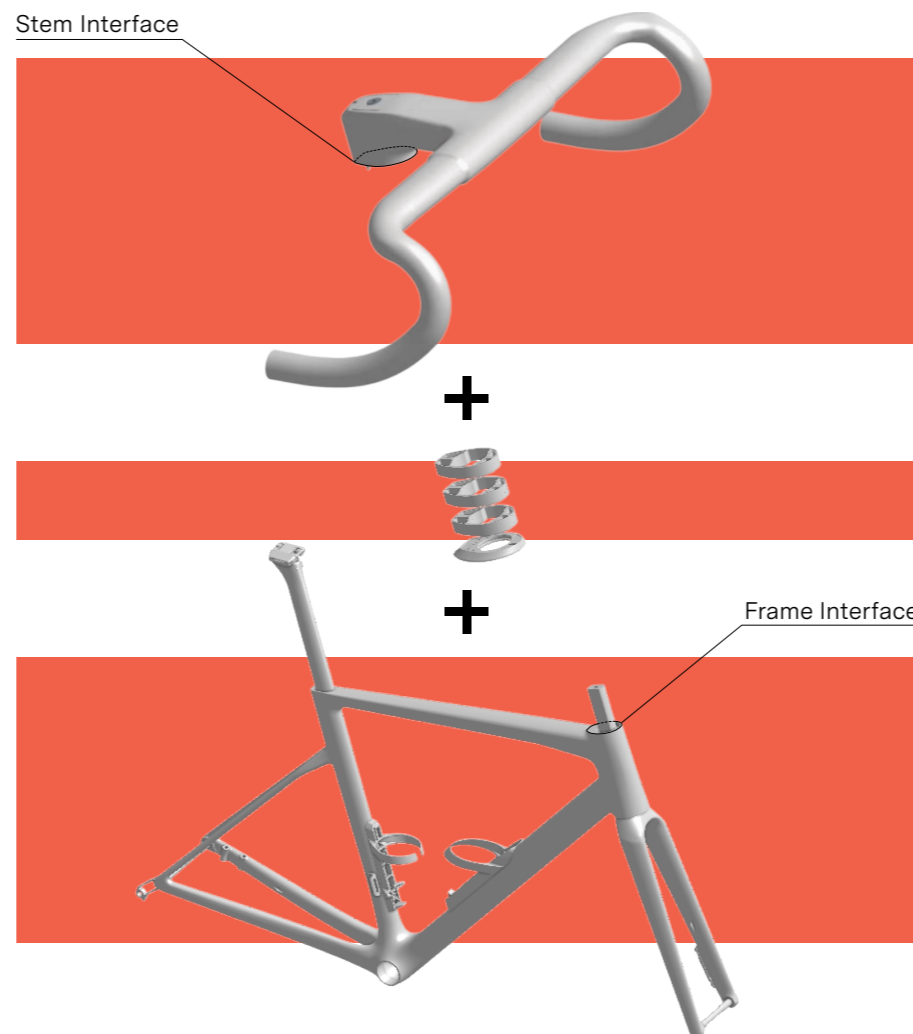

When you START WITH A COCKPIT OR STEM

Check [2] **Stem Interface**.



In [1] **Frame Interface**,
find a frame with the same interface.



Pick matching Top Cone and Spacers suggested by [2] **Stem Interface**.



Identifying ICS Spacers Design generation

ICS has evolved in time. ICS2 is now featuring more complex top cones and spacer shapes to provide an even stronger and more aesthetic final assembly.

ICS 1

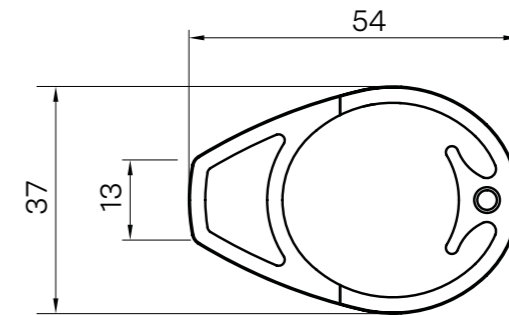

ICS 2

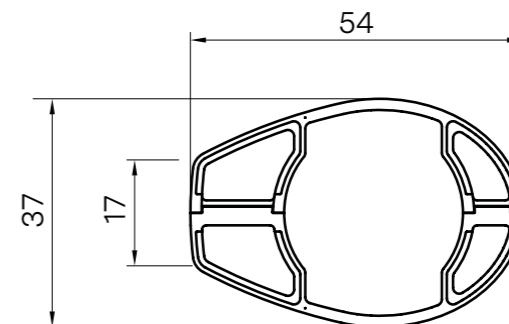
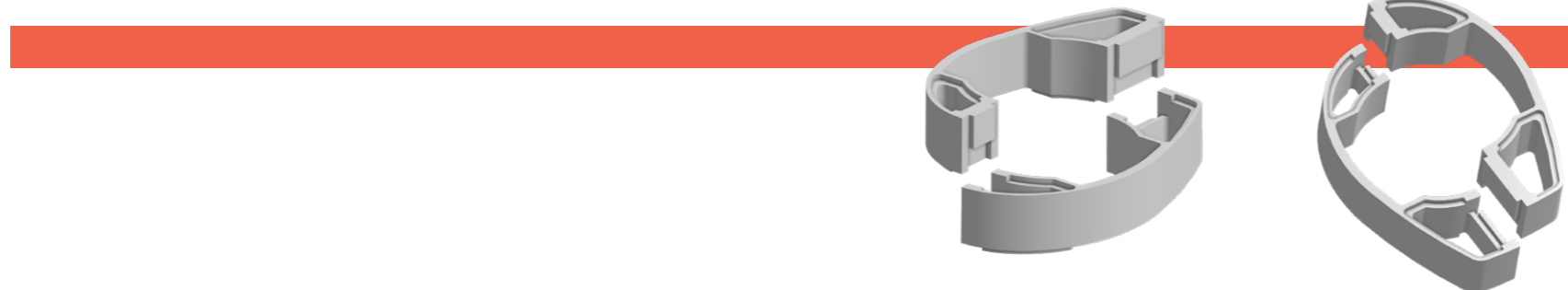

[1] Frames Interface

		ICS Interface							
		Aero 62x47-17	Aero recessed 57x47	Aero 1 1/4 62x47-17	Classic 60x47-25	Classic 1 1/4 60x47-25	Round headtube	Timemachine Road Gen 2 67 x 48-27	Roadmachine Gen 1 75 x 63-42

From To

Teammachine SLR				
Teammachine SLR 01 Gen5	MY26	MY26	Gen 5	✓
Teammachine SLR Gen4.5	MY26	MY26	Gen 4.5	✓
Teammachine SLR 01 Gen4	MY21	MY24	Gen 4	✓
Teammachine SLR Gen4	MY21	MY24	Gen 4	✓
Teammachine SLR 01 Disc Gen3	MY18	MY20	Gen 3	✓
Teammachine SLR 02 Disc Gen3	MY18	MY20	Gen 3	✓
Teammachine R				
Teammachine R 01 (47-56)	MY24	-	Gen 1	✓
Teammachine R 01 (58-61)	MY24	-	Gen 1	✓
Teammachine R MPC (47-56)	MY26	-	Gen 1	✓
Teammachine R MPC (58-61)	MY26	-	Gen 1	✓
Timemachine Road				
Timemachine Road 01	MY19	MY23	Gen 2	✓
Roadmachine				
Roadmachine 01 Gen3	MY24	MY26	Gen 3	✓
Roadmachine Gen3	MY24	MY26	Gen 3	✓
Roadmachine 01 Gen2	MY20	MY23	Gen 2	✓
Roadmachine Gen2	MY20	MY23	Gen 2	✓
Roadmachine Masterpiece	MY20	MY23	Gen 2	✓
Roadmachine 01 Gen1	MY17	MY19	Gen 1	✓
Roadmachine 01 AMP (TQ)	MY23	-		✓
Roadmachine AMP (Mahle)	MY22	MY23		✓
Kaius				
Kaius 01 Gen1	MY23	MY24	Gen 1	✓
Kaius 01 Gen1.5	MY26	MY26	Gen 1.5	✓
URS				
URS 01	MY24	MY26	Gen 2	✓
URS	MY24	MY26	Gen 2	✓
URS 01 LT	MY24	MY26	Gen 2	✓
UnReStricted 01	MY20	MY22	Gen 1	✓
UnReRestricted	MY20	MY22	Gen 1	✓
UnReRestricted 01 LT	MY20	MY22	Gen 1	✓
URS AL	MY22	MY24	Gen 1	✓
Alpenchallenge & 257				
Alpenchallenge AMP	MY19	MY21		✓
Alpenchallenge AL	MY23	-		✓
Alpenchallenge AMP AL	MY23	MY24		✓
257 AL	MY23	MY24		✓
257 AMP AL SPEED	MY23	MY24		✓

[2] Stem Interface

Compatible Part Numbers for Top Cones and Spacers.

		ICS Interface										
ASTM level	Stem interface	Aero 62x47-17	Aero recessed 57x47	Aero 1 1/4 62x47-17	Classic 60x47-25	Classic 1 1/4 60x47-25	Round headtube	Timemachine Road Gen 2 67 x 48-27	Roadmachine Gen 1 75 x 63-42			
Cockpit ICS Carbon Aero Mpc.	30007862 30007863 30007864 30007865		ASTM2 road + gravel	ICS2	30001801	30006290	30006290	30001804	Not Compatible	30002039	30003732	Not Compatible
Cockpit ICS Carbon Aero Gen2	30007867 30007868 30007869 30007870 30007871 30007872 30007873 30007874 30007875 30007876 30007877 30007878 30007879 30007880		ASTM2 road + gravel	ICS2	30001801	30006290	30006290	30001804	Not Compatible	30002039	30003732	Not Compatible
Cockpit ICS Carbon Aero	30003720 30003721 30003722 30003723 30003724 30003725 30003726		ASTM2 road + gravel	ICS2	30001801	30006290	30006290	30001804	Not Compatible	30002039	30003732	Not Compatible
Cockpit ICS Carbon Aero	30003706 30003707 30003708 30003709 30003710 30003711 30003712		ASTM2 road + gravel	ICS2	30001802	30006289	30006289	30001804	Not Compatible	30002039	30003734	Not Compatible
Cockpit ICS Carbon Aero	30003713 30003714 30003715 30003716 30003717 30003718 30003719		ASTM2 road + gravel	ICS2	30003256	30006291	30006291	30001804	Not Compatible	30002039	30003733	Not Compatible

[2] Stem Interface

Compatible Part Numbers for Top Cones and Spacers.











		ICS Interface										
ASTM level	Stem interface	Aero 62x47-17	Aero recessed 57x47	Aero 1 1/4 62x47-17	Classic 60x47-25	Classic 1 1/4 60x47-25	Round headtube	Timemachine Road Gen 2 67 x 48-27	Roadmachine Gen 1 75 x 63-42			
Cockpit ICS Carbon EVO	30005534 30005535 30005536 30005537 30005538 30005539 30007411 30007412 30007413		ASTM2 road +gravel	ICS2	30001801	30006290	30006290	30001804	Not Compatible	30002039	30003732	Not Compatible
Cockpit ICS Carbon EVO	30005540 30005541 30005542 30005543 30005544 30005545		ASTM2 road +gravel	ICS2	30001802	30006289	30006289	30001804	Not Compatible	30002039	30003734	Not Compatible
Cockpit ICS Carbon EVO	30005546 30005547 30005548 30005549 30005550 30005551		ASTM2 road +gravel	ICS2	30003256	30006291	30006291	30001804	Not Compatible	30002039	30003733	Not Compatible
Cockpit ICS Carbon	30001767 30001768 30001769 30001770		ASTM1 road	ICS2	30001801	30006290	30006290	30001804	Not Compatible	30002039	30003732	Not Compatible
Cockpit ICS Carbon	30001775 30001776 30001777 30001778"		ASTM1 road	ICS2	30001802	30006289	30006289	30001804	Not Compatible	30002039	30003734	Not Compatible
Cockpit ICS Carbon	30003257 30003258 30003259 30003260		ASTM1 road	ICS2	30003256	30006291	30006291	30001804	Not Compatible	30002039	30003733	Not Compatible

[2] Stem Interface







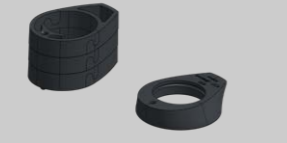

Compatible Part Numbers for Top Cones and Spacers.

		ICS Interface										
ASTM level	Stem interface	Aero 62x47-17	Aero recessed 57x47	Aero 1 1/4 62x47-17	Classic 60x47-25	Classic 1 1/4 60x47-25	Round headtube	Timemachine Road Gen 2 67 x 48-27	Roadmachine Gen 1 75 x 63-42			
Stem ICS2	30001784 30001785 30001786 30001787 30001788 30001789 30001790		ASTM2 road +gravel	ICS2	30001801	Not Compatible	30006290	30001804	Not Compatible	30002039	30003732	Not Compatible
Stem ICS2 MTT	30002032 30002033 30002034 30002035 30002036		ASTM2 road +gravel	ICS2	30001801	Not Compatible	30006290	30001804	Not Compatible	30002039	30003732	Not Compatible
Stem RSM01 with RSM01 ICS Kit - Cable Guide And Rear Cover	30002072 30002073 30002074 30002075 30007807 30007808 with 30007594		ASTM2 road +gravel	ICS2	30001801	Not Compatible	30006290	30001804	Not Compatible	30002039	30003732	Not Compatible
Stem MTT Fork	30002076 30002077 30002078		ASTM2 road +gravel	1 1/4	Not Compatible	30006272	Not Compatible	Not Compatible	30004844	Not Compatible	Not Compatible	Not Compatible
Stem ICS Aero Ø25mm bar bore	30001791 30001792 30001793 30001794		ASTM1 road	ICS1	30001800	Not Compatible	Not Compatible	30001803	Not Compatible	30004313	30003735 Low 301706 High 301705	Low 300713 High 300712
Stem ICS	30001795 30001796 30001797 30001798 30001799		ASTM2 road +gravel	ICS1	30001800 external cable routing = add 302221 cable guide	Not Compatible	Not Compatible	30001803 external cable routing = add 302221 cable guide	Not Compatible	30004313 + 302221 cable guide	30003735 Low 301706 High 301705	Low 300713 High 300712

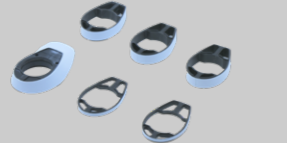
[3] Top Cones & Spacers

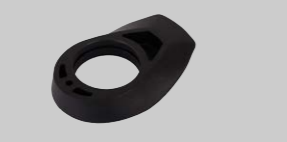
		Product Name	Frame Interface	ICS Interface	
Aero 62x47-17					
30001801		Topcone Set ICS2 ICS Carbon	Aero 62x47-17	ICS2	top cones #1 (5mm) and #2 (30mm), 3x10mm spacers and 2x3mm spacers
30001802			top cones #1 (5mm) and #2 (30mm), 3x10mm spacers and 2x3mm spacers		
30003256			top cones #1 (5mm) and #2 (30mm), 3x10mm spacers and 2x3mm spacers		
30001800		Topcone Set SLR 01 ICS1 ICS AERO ICS	Aero 62x47-17	ICS1	top cones #5 (5mm) and #6 (30mm), 3x10mm spacers
30006272		Topcone URS Gen 2 MTT Fork	Aero 1 1/4 62x47-17	1 1/4	top cone low (8mm)
Aero recessed 57x47					
30006290		Topcone Set ICS2 Teammachine R 01	Aero recessed 57x47	ICS2	top cones #12 (5mm) and #13 (30mm), 3x10mm spacers
30006289			top cones #12 (5mm) and #13 (30mm), 3x10mm spacers		
30006291			top cones #12 (5mm) and #13 (30mm), 3x10mm spacers		
Classic 60x47-25					
30001804		Topcone Set RM01 ICS2 ICS Carbon	Classic 60x47-25	ICS2	top cones #3 (5mm) and #4 (30mm), 3x10mm spacers, 2x3mm spacers
30001803		Topcone Set RM01 ICS1 ICS AERO ICS	Classic 60x47-25	ICS1	top cones low H2062 (5mm) and high (30mm), 3x10mm spacers
30004844		Topcone for MTT Fork	Classic 1 1/4 60x47-25	1 1/4	top cone low (5mm)

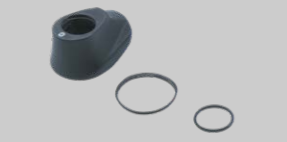
[3] Top Cones & Spacers

		Product Name	Frame Interface	ICS Interface	
Round headtube					
30002039		Topcone Set ICS2 round 257 AMP	Round headtube	ICS2	top cones #9, 3x10mm spacers, 2x3mm spacers
30004313		Topcone Set ICS1 round 257 (3x10mm spacers)	Round headtube	ICS1	top cones #10, 3x10mm spacers
Timemachine Road Gen 2 67 x 48-27					
30003732		Topcone Set ICS2	Timemachine Road Gen 2 67 x 48-27	ICS2	top cones #8, 3x10mm spacers, 2x3mm spacers
30003734			Timemachine Road Gen 2 67 x 48-27		top cones #8, 3x10mm spacers, 2x3mm spacers
30003733			Timemachine Road Gen 2 67 x 48-27		top cones #8, 3x10mm spacers, 2x3mm spacers
30003735		Topcone Set ICS1	Timemachine Road Gen 2 67 x 48-27	ICS1	top cones low and high, 3x10mm spacers
301706		Timemachine Road 01 Topcone Low	Timemachine Road Gen 2 67 x 48-27		top cone low
301705		Timemachine Road 01 Topcone High	Timemachine Road Gen 2 67 x 48-27		top cone high
Roadmachine Gen 1 75 x 63-42					
300713		Roadmachine 01 Topcone Low	Roadmachine Gen 1 75 x 63-42	ICS1	top cone low
300712		Roadmachine 01 Topcone High	Roadmachine Gen 1 75 x 63-42	ICS1	top cone high
302221		Stem ICS01 Lower Stem Cover-Round Steerer		ICS1	Cable guide